

NIR- LED- Technology
Continuous In-Line measurement of two organic components

HK3 HK3-MINI

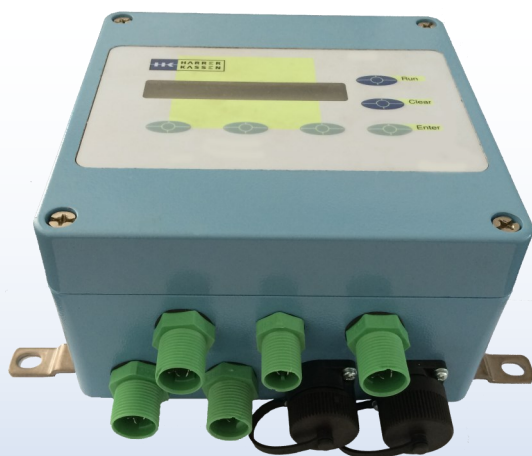
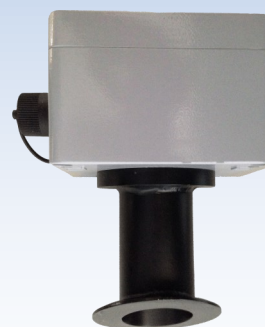

Harrer & Kassen GmbH
Am Heschen 4 - 6
D - 75328 Schömberg—Langenbrand

Tel.: +49 (0)7084/9248-0
Fax: +49 (0)7084/9248-29
www.harrerkassen.com
info@harrerkassen.com

Description:

The HK3 Series are NIR- (Near Infrared) LED In-Line measurement devices with state-of-the-art technology.

The devices are used on conveyor belt, in pipelines (connection via flow-through measuring cell or flange) and in tanks / vessel.

Through the modular construction (Sensor and evaluation unit are separate), the sensor can be installed at a different accessible places and the evaluation unit can be installed at a well accessible place. This ensure the easy handling.

The modular construction makes the operation of the HK3- Series very easy.

Advantage:

- Stat-of-the-art NIR- Technology
- Real time measurement
- Continuous monitoring of the whole production
- No moving parts in the optic, like filter wheel
- Easy to use software
- Open system:
 - existing calibration can be expanded
 - new calibrations can be created independent
- 10 Spectra's are evaluated per sec.
- Life time of the LED's approx. 10 Years
- No drift of the measured values through lamp aging
- Color and distance independent measurement
- Early detection of fail production
- Maintenance free

Applications:

Food

Sugar
Sugar beets
Refined sugar
Sugar cubes
Pellets
Starch
breadcrumbs
Milk powder
Cheese
Pasta
Herbs drying
Coffee & Tea
Animal feed
Pellets

Building material

Cement
Gypsum
Clay (roof tiles)
Sand
CaCO₃
Al₂(OH)₃
Gravel
Tobacco
Cut-tobacco
Fine-cut tobacco
Cigar tobacco
Snuff tobacco

Boards / Flooring

Mineral board
acoustic board
PVC (coating)
Wood products
Fibre board (MDF)
Chipboard (OSB)
Wood pellets

Other

Coal
Plastic granulate
Textile
Paper
Biomass

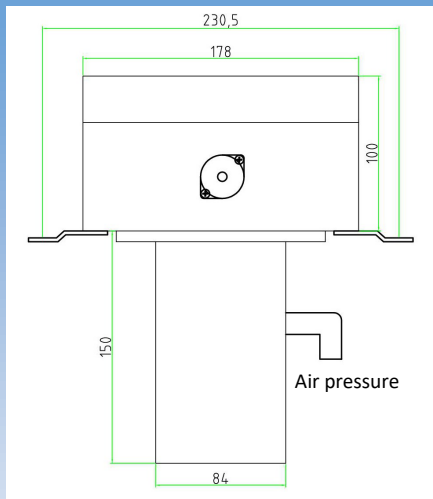
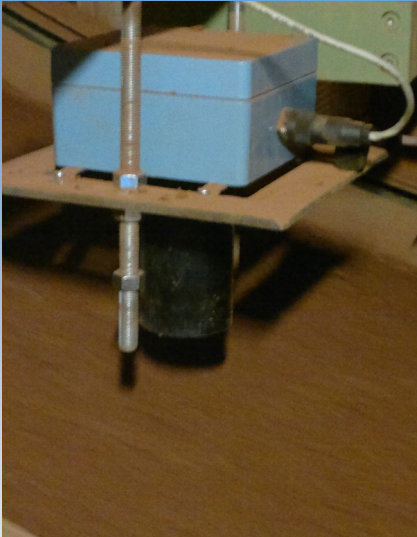

HK3 Standard for applications on conveyor belt

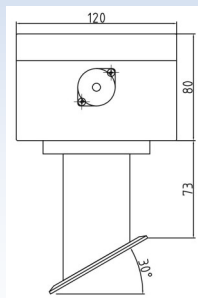

HK3-MINI with connection for flow-through measuring cell

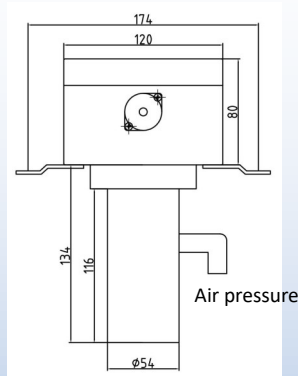

HK3-MINI for applications on conveyor belt

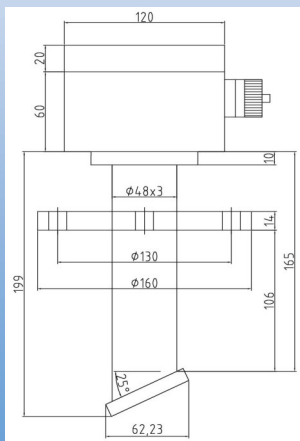

HK3-MINI with flange for measuring in pipelines, tanks and vessels

Technical sensor data:

Housing:	Aluminum die casting
Size H x W x D:	180 x 180 x 100mm 122 x 120 x 80mm
Protection Type:	IP65 / NEMA 4
Environmental temperature:	-20°C - +50°C
Product temperature:	>0°C - +70°C

Evaluation unit

Technical data evaluation unit:

Housing:	Aluminum die casting
Size H x W x D:	180 x 180 x 100 mm
Weight:	ca. 2,5 kg
Protection Type:	IP65 / NEMA 4
Power supply:	100 - 240 V/AC optional 24V/DC – 50/60 Hz – max. 200mA
2 Analog outputs:	0/4 - 20mA / isolated 1500V
PROFI-BUS-DP:	optional
Environmental temperature:	-20°C - +50°C
Operation:	6 in membrane keypad integrated soft keys
Display:	2x24 sign LCD, LED– backlight
PC-interface:	RS232

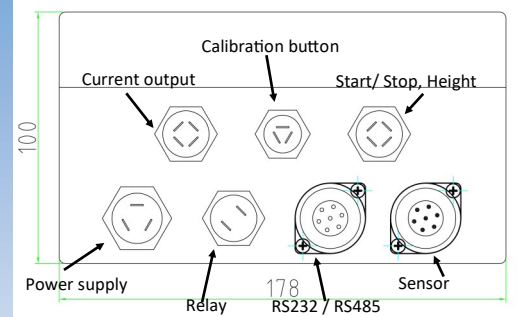

No moving parts in the optic:

The Harrer & Kassen GmbH use in his HK3- Series NIR (Near-Infrared) LEDs with specific wavelength and no filter wheel, like conventional measuring devices.

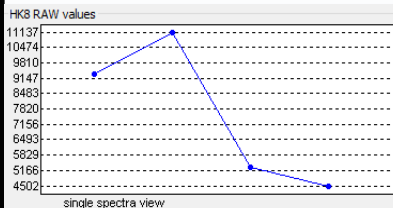
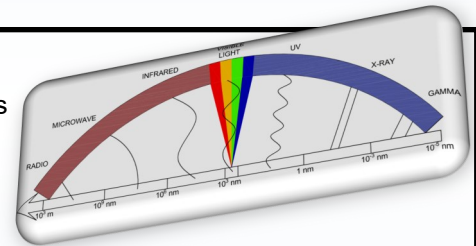

The product will be irradiated with LEDs of different wavelength.

The resulting diffuse reflection (the diffuse reflection contains the necessary information of the constituents) is received by a photodiode and a MINI-Spectra is generated. Out of the received MINI- Spectra we can create a calibration with our SPECTER3 software.

Due to the open software system, it is possible that our customers can create their own calibration or he expand an existing calibration.

Scope of supply:

All HK3 are supplied with sensor, evaluation unit, calibration button and software.

At the commissioning, the operating personal gets a device instruction / training.

PC– requirement:

- 300 MHz clock speed (at least) recommended Pentium III- Processor (or faster)
- Windows 7 (32 und 64 Bit) or higher
- 512 MB RAM (or higher)
- USB interface

Directives:

The HK3 and HK3– MINI is CE- conform, according to the followings directives:

- EMC directives 2014/30/EU:
 - generic standards EN 61000-6-2
 - generic standards EN 61000-6-4
- Low- voltage directives 2014/35/EU
- RoHS directives 2011/65/EU